

DOCUMENTO EXAME

PROGRAMA DE ARQUITETURA

LABORATÓRIO DE PROJETO VI

BEATRIZ LOURENÇO ANASTÁCIO | 20161060 | 5B MIINT

- Análise histórica



- Análise urbana / proposta

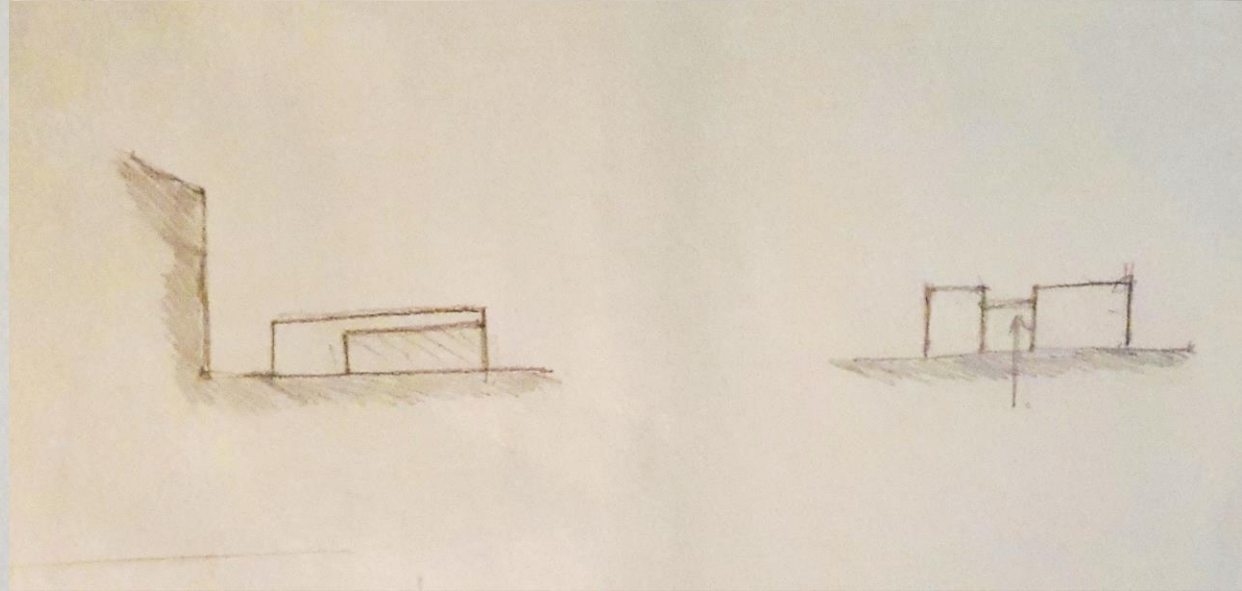
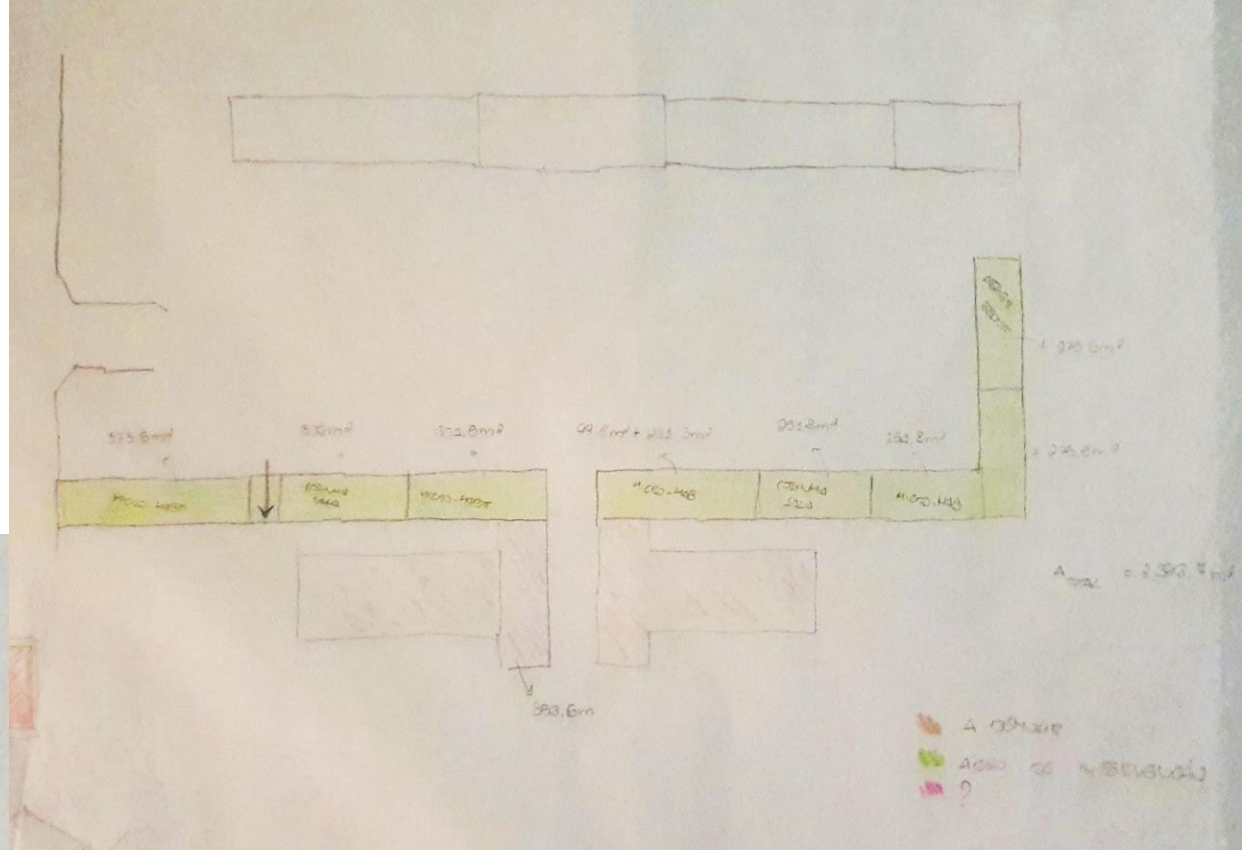
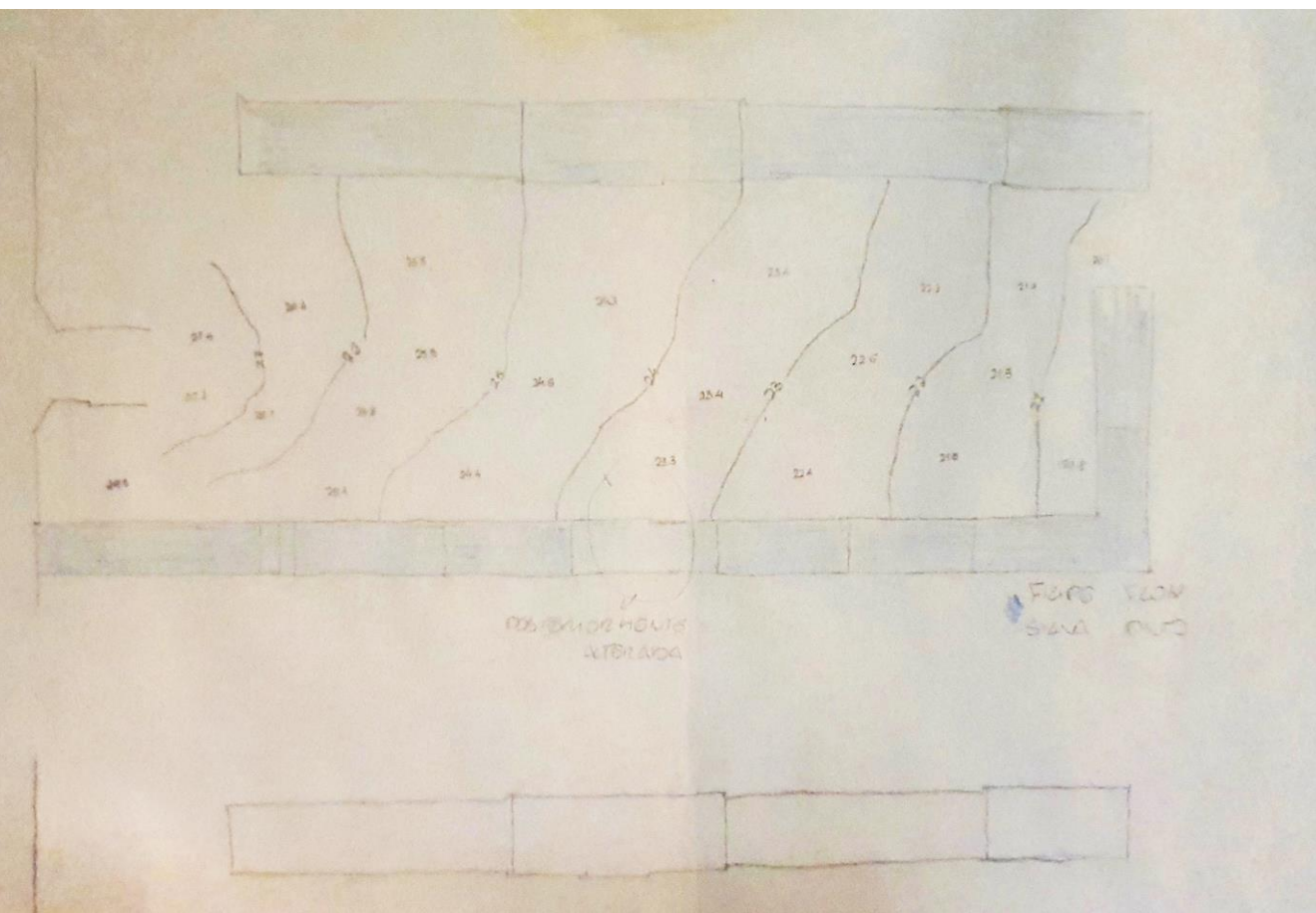

- Estudo exterior

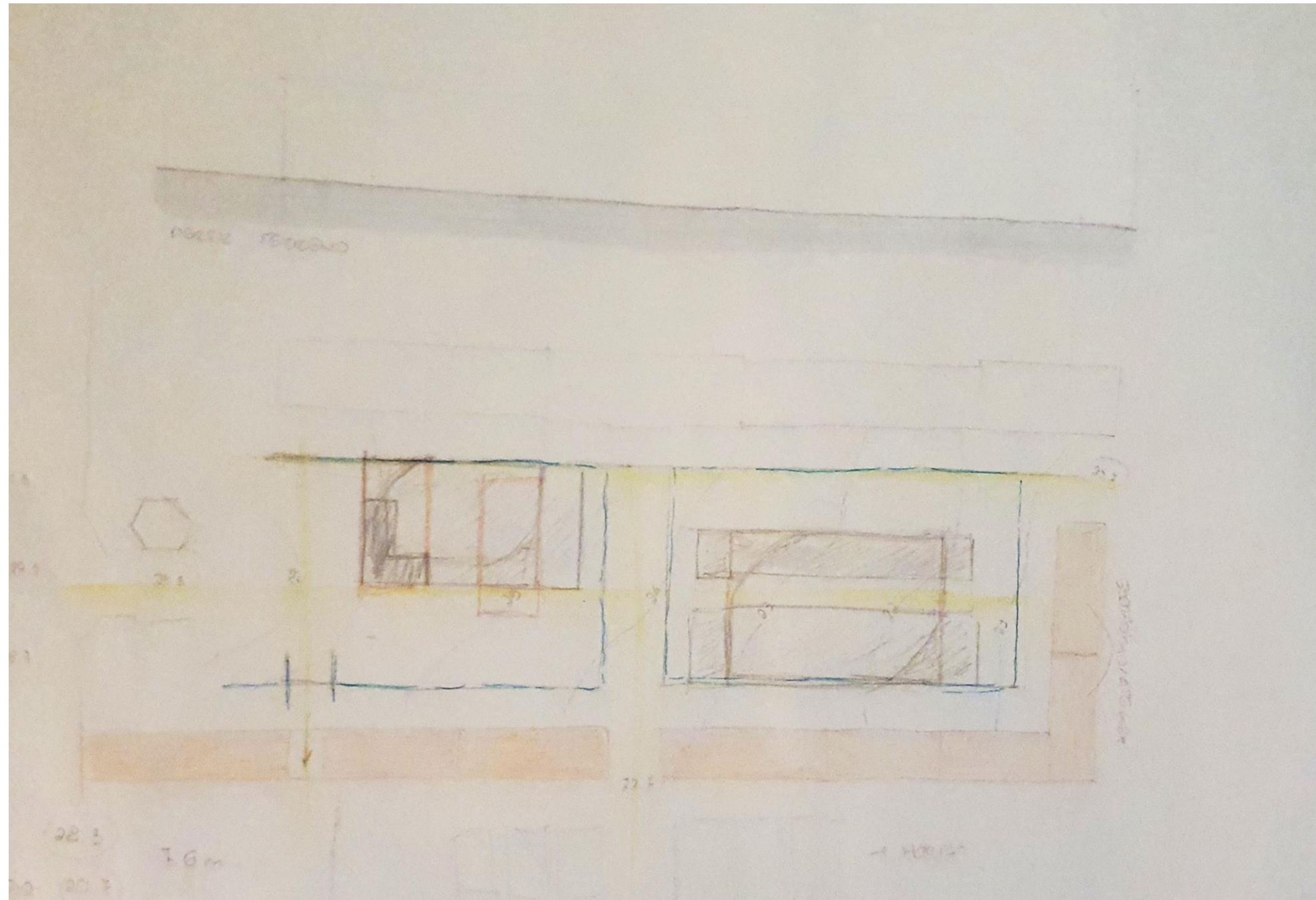

- Proposta



- Estudo de Alçados

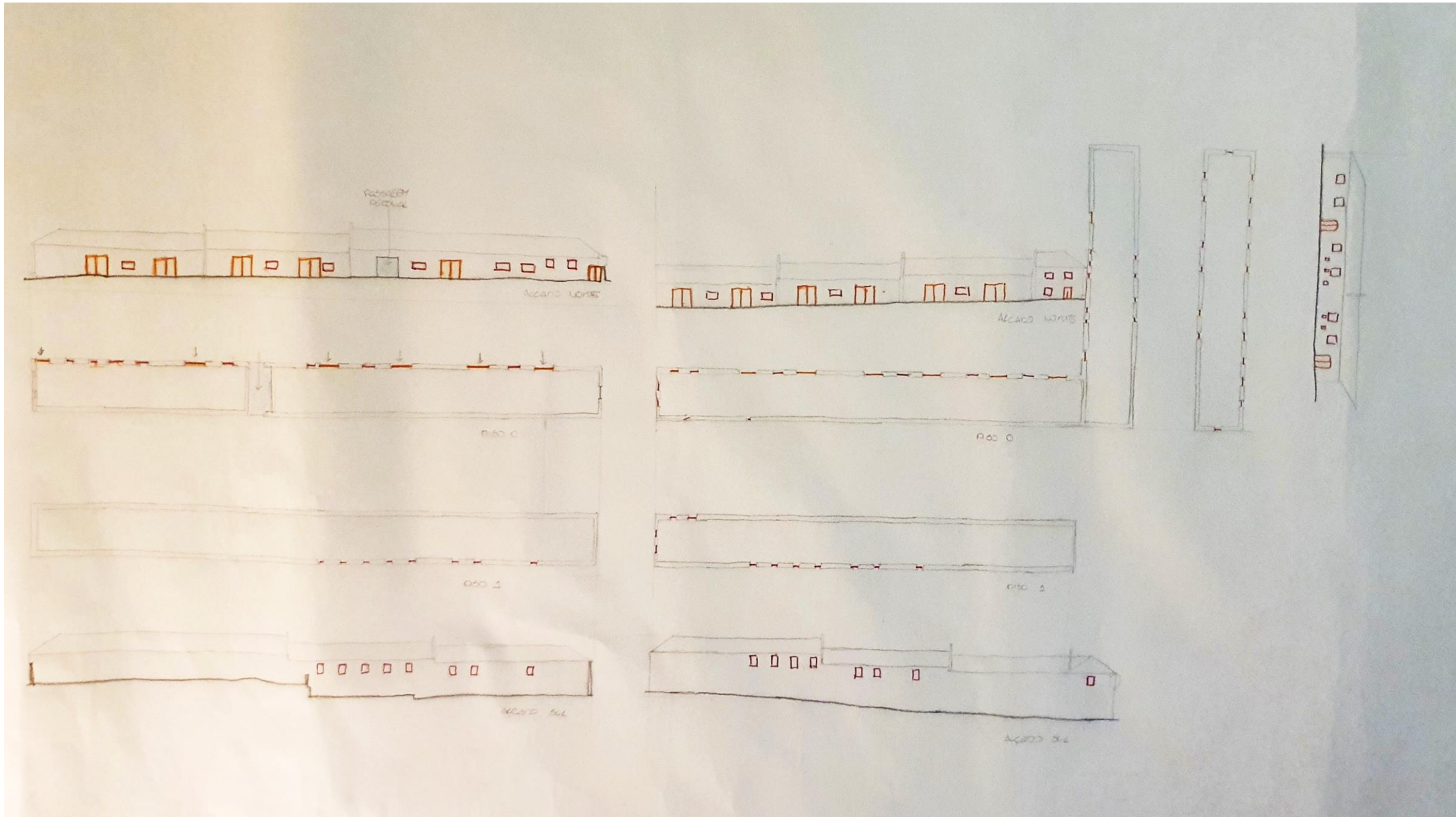

- Amarelos e Vermelhos

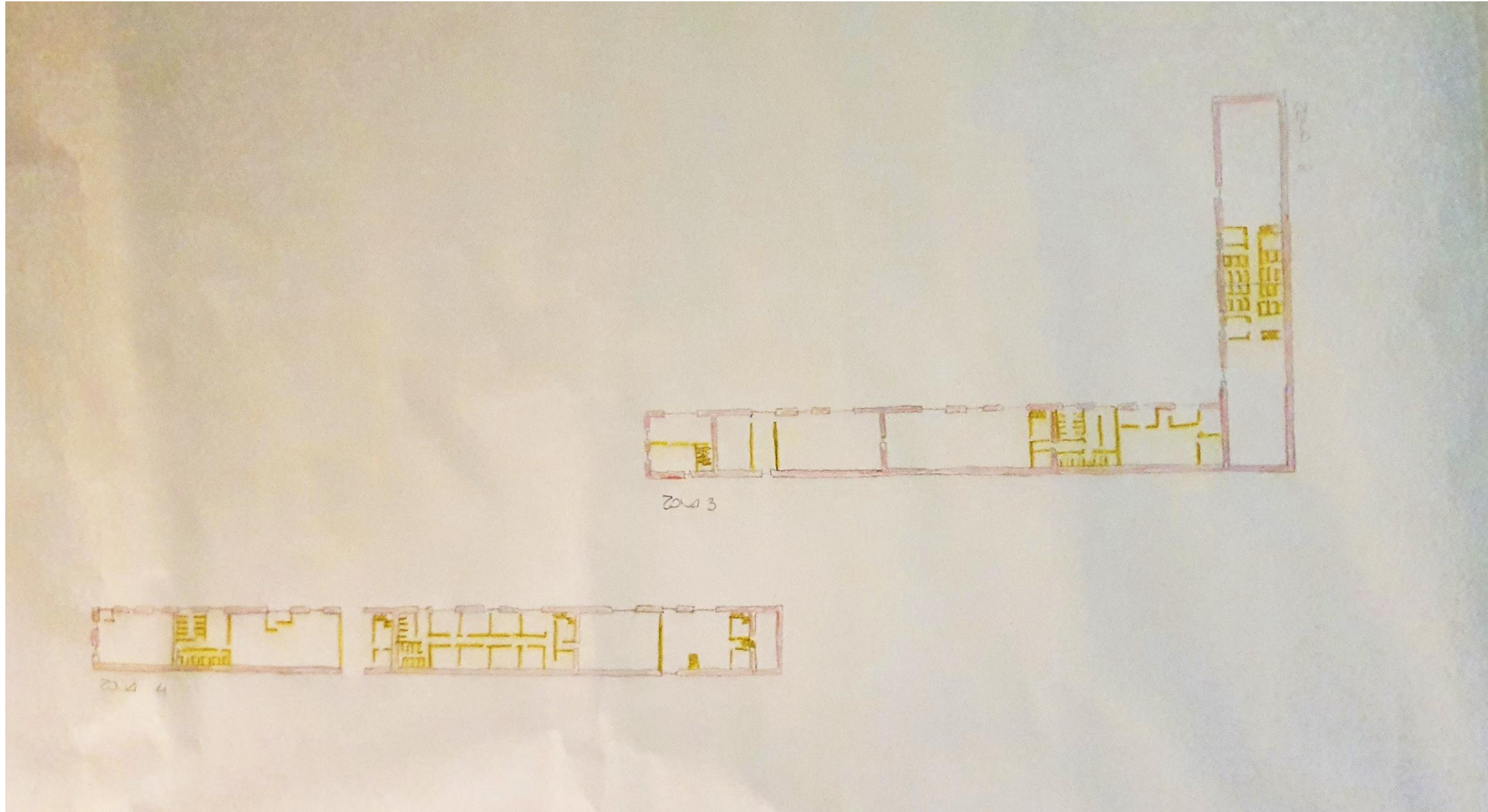

- Estudo da organização do espaço interior

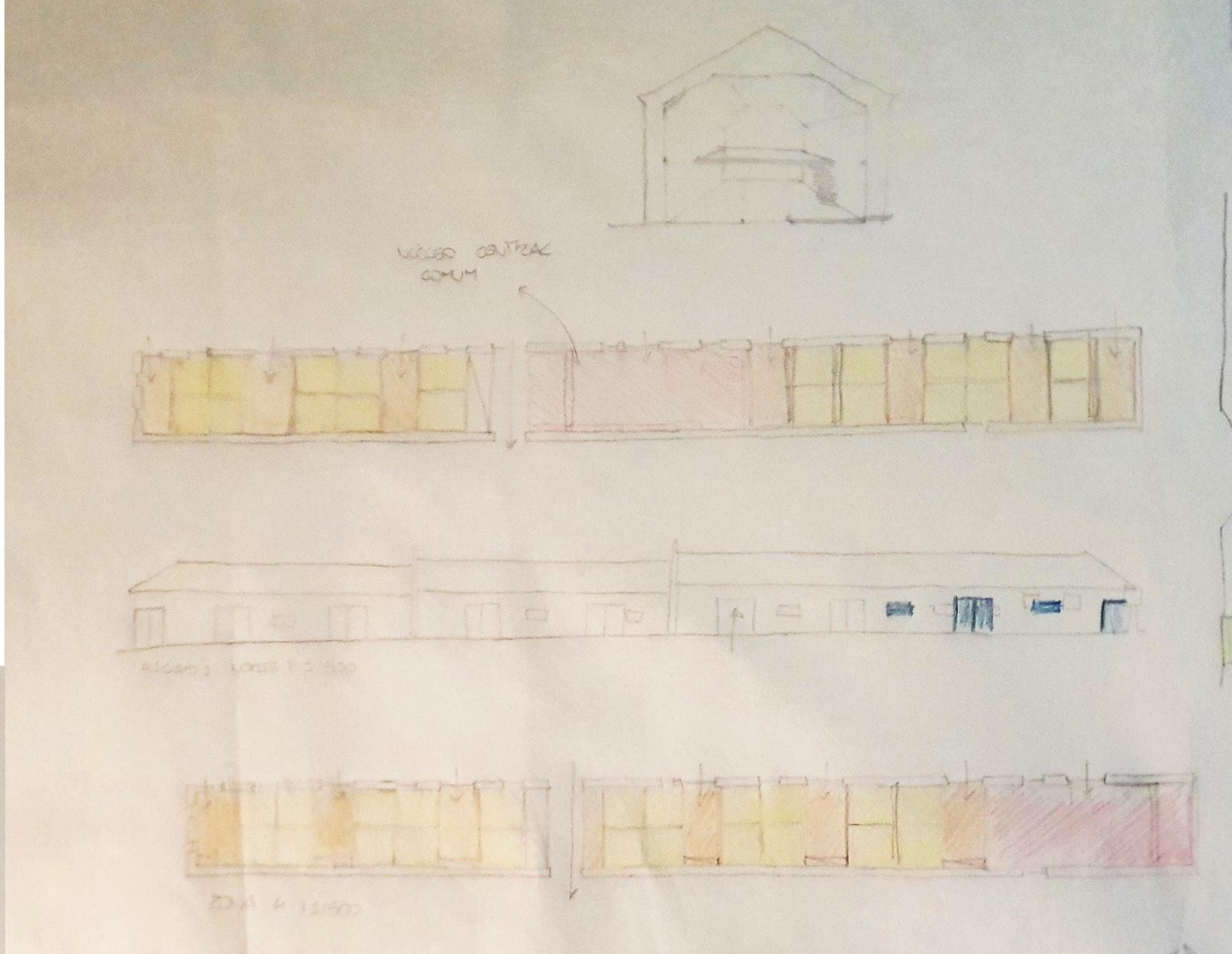
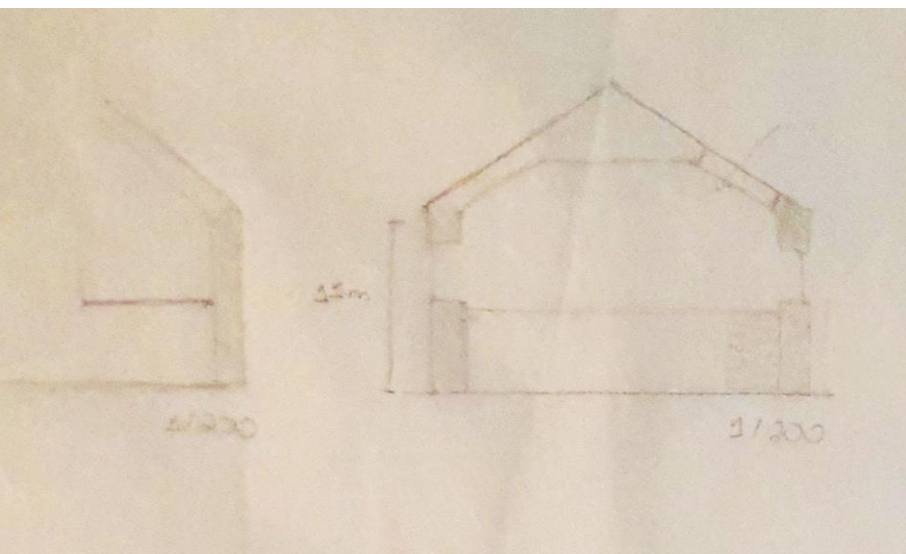



- Maquete Analítica | 3d

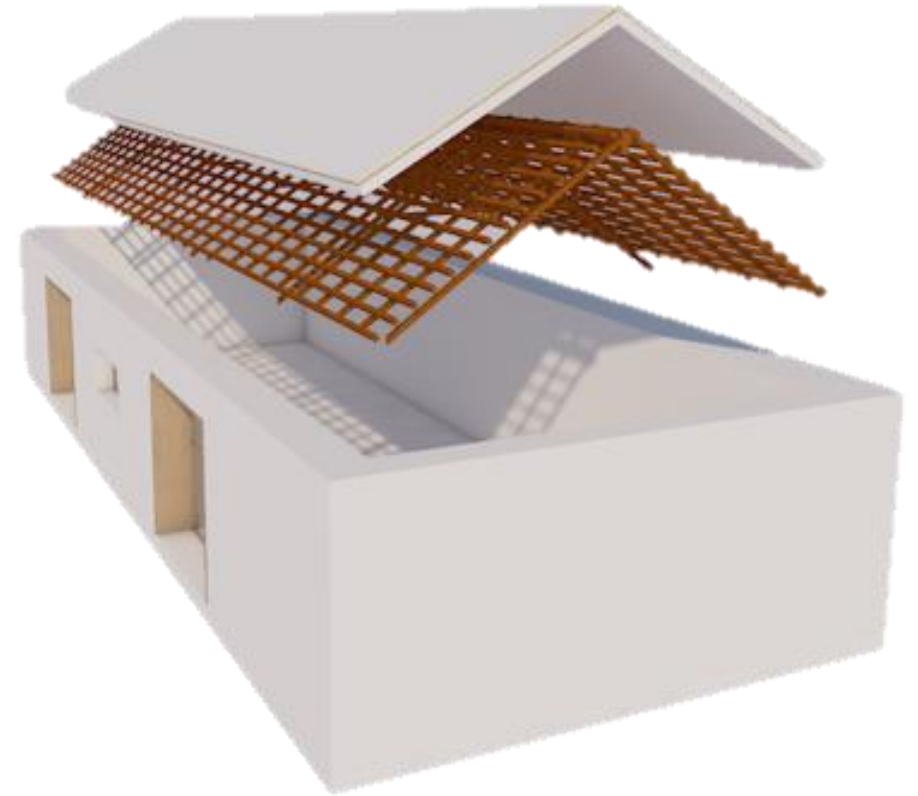
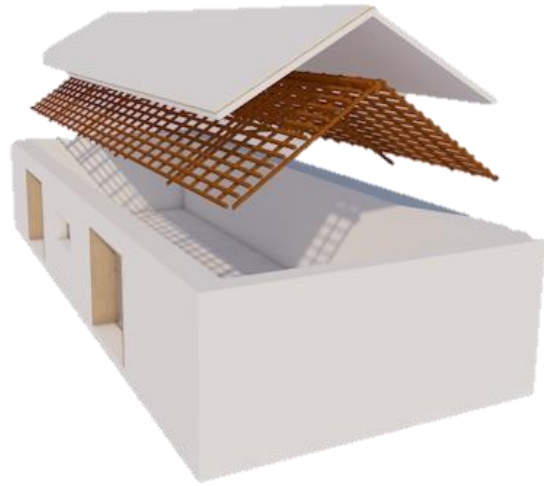

- MAQUETES

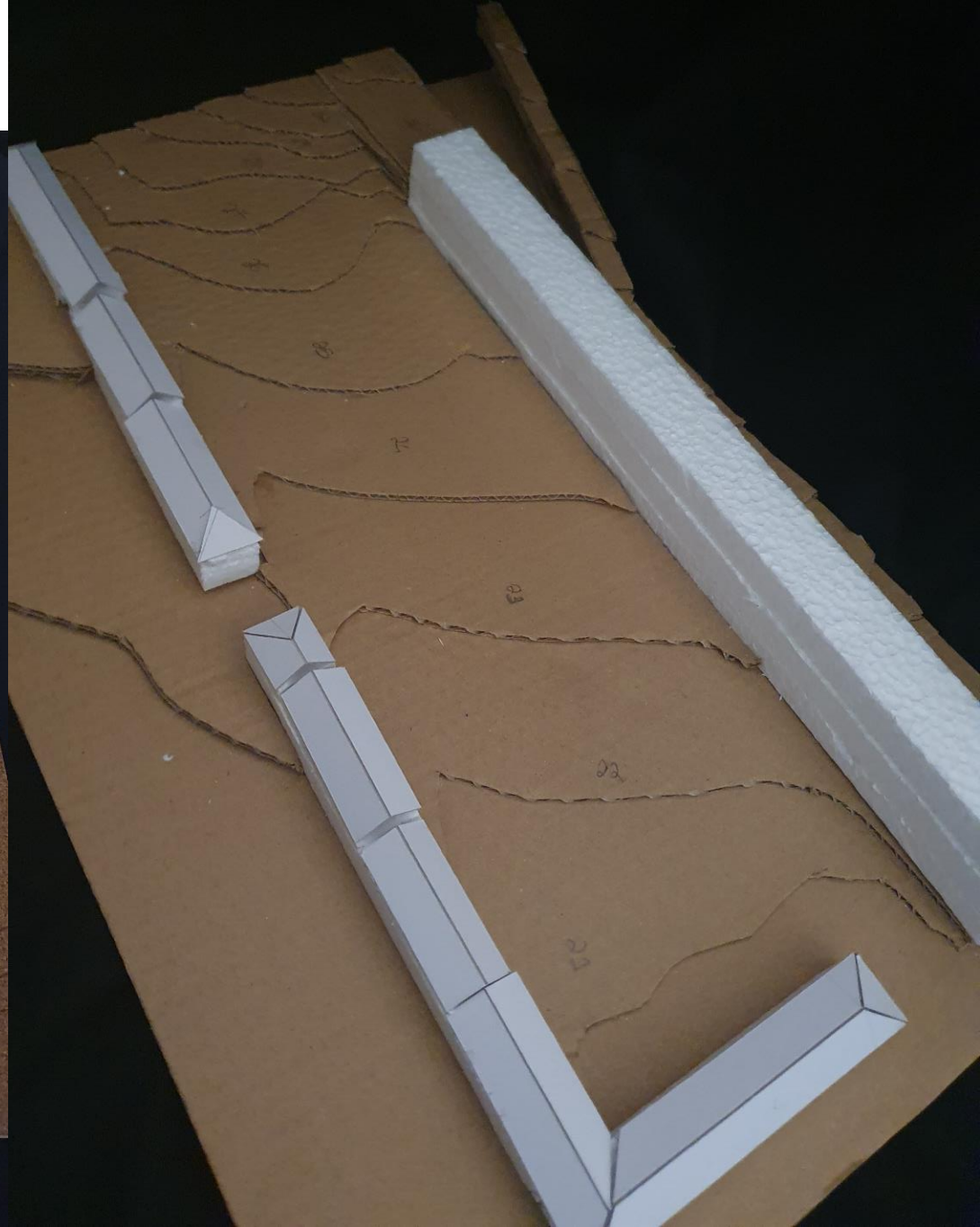
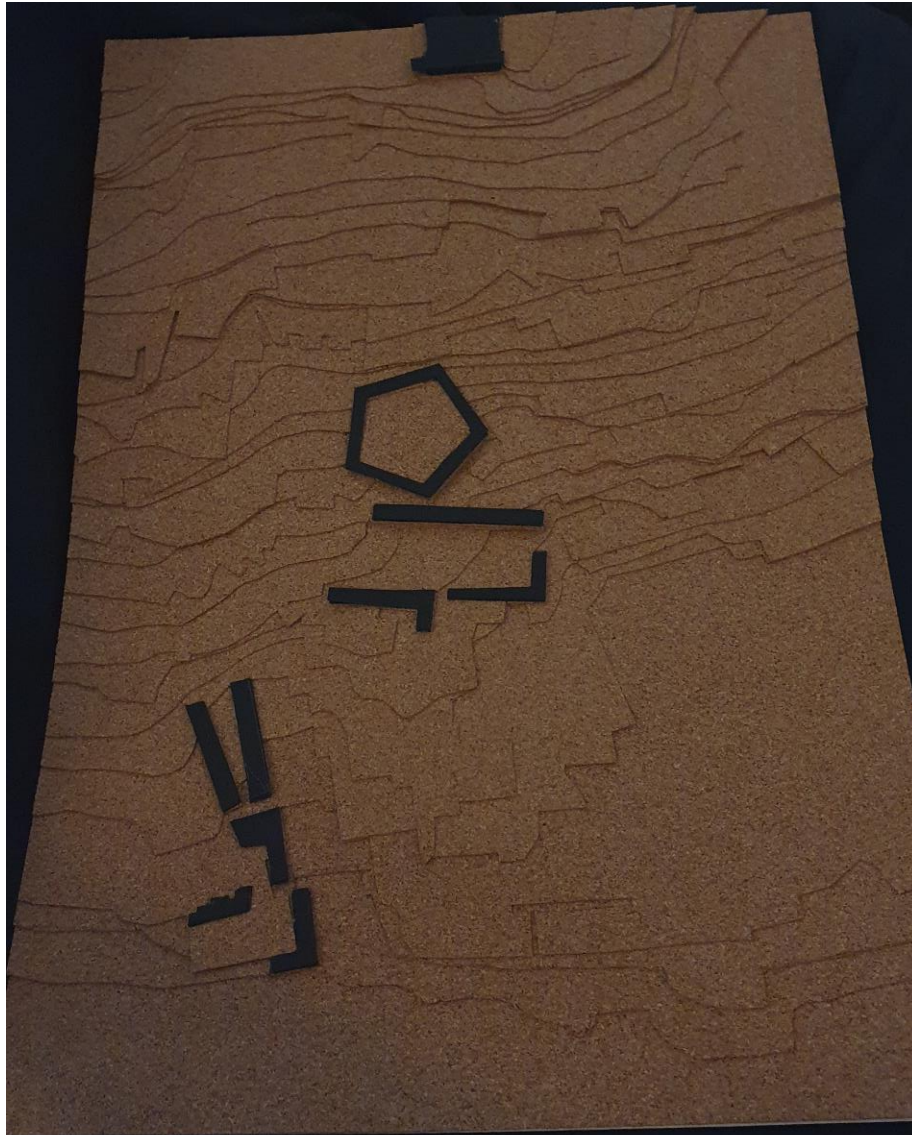

• TERRENO

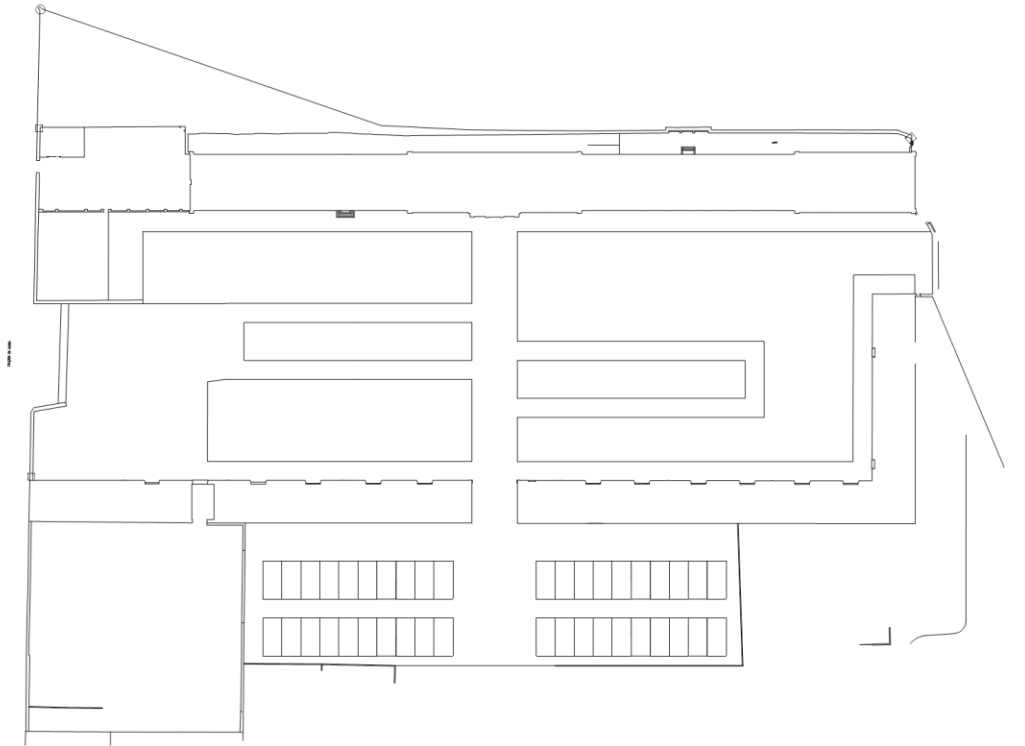

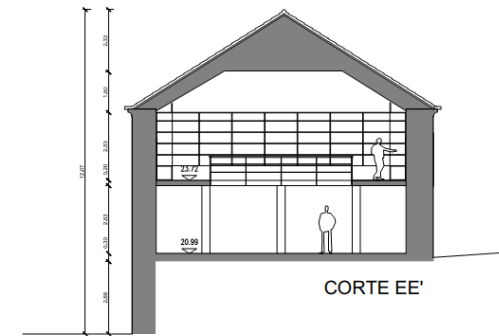
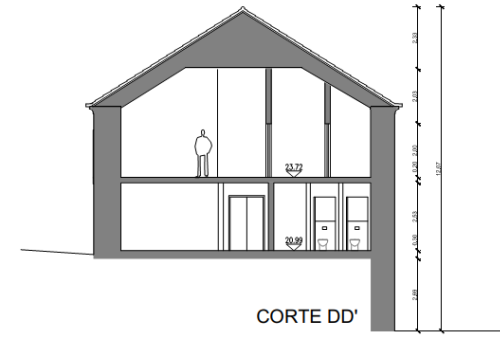

CORTE FF'

CORTE DD'

CORTE EE'

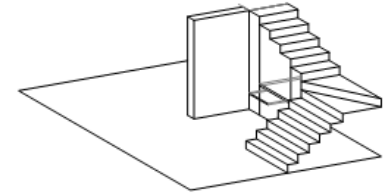
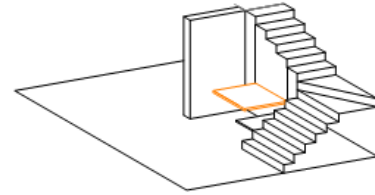
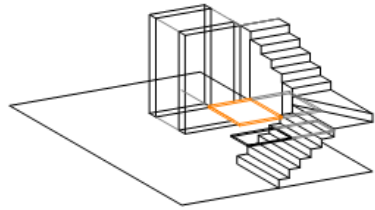
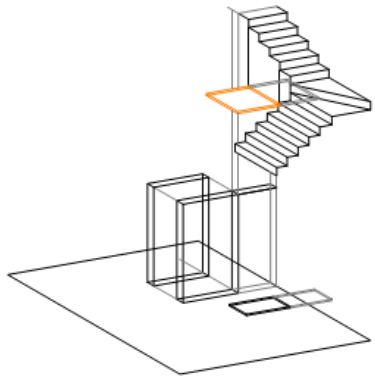

• 3D



• 3D

